

## FL-65.01

**MATERIAL:** Zamac;  
**ACABAMENTO:** Cromado;  
**QUANTIDADE DE SEGREDOS:** Sob consulta;  
**OPÇÕES DE SEGREDOS:** Segredos iguais, diferentes ou sistema de mestragem;  
**APLICAÇÃO:** Móveis de aço.

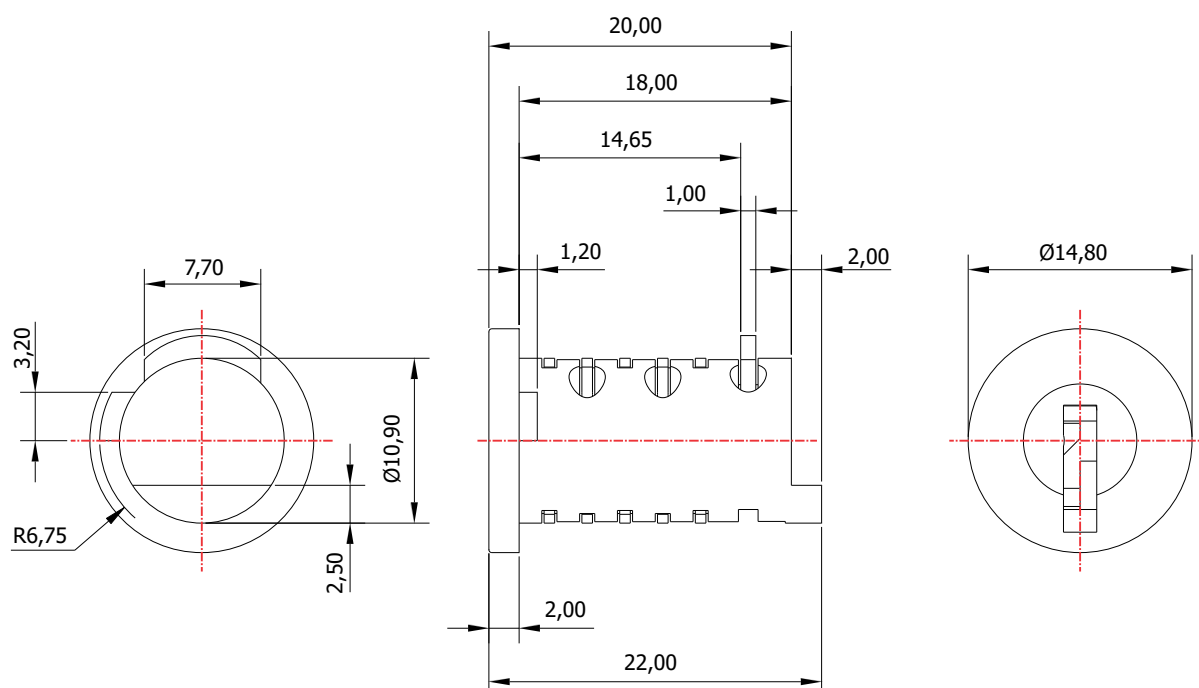
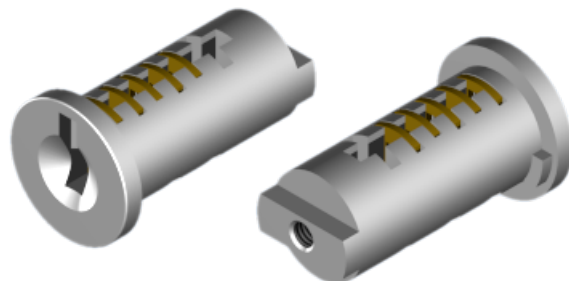

### TIPOS DE CHAVES

Chave plana  
Opção: Latão ou Zamac



Chave com cabeça  
plástica escamoteável  
Opção: Latão ou Zamac



Chave com cabeça  
plástica fixa  
Opção: Latão ou Zamac

